

161820 TWO ARM SOFA

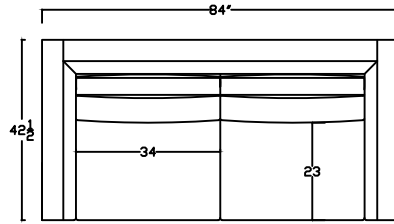

161851 TWO ARM CONDO

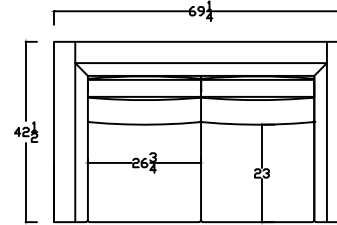

161813 TWO ARM LOVESEAT

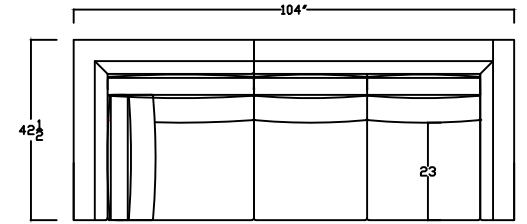

161818R ONE ARM SOFA W/RETURN

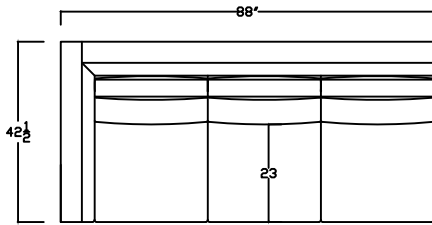

161817L ONE ARM SOFA

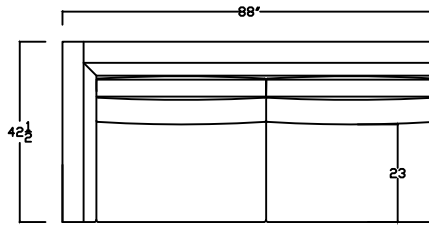

161817LX ONE ARM SOFA
2 seat cushions

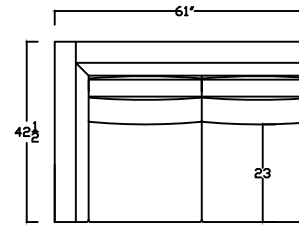

161810L
ONE ARM LOVESEAT

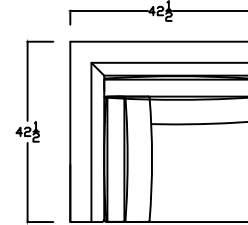

161805 CORNER



*NOT TO SCALE

FRONT

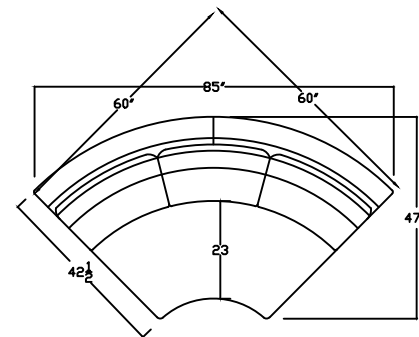

1618104 ARMLESS CURVE CORNER

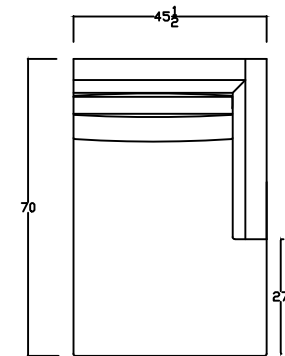

161807R ONE ARM CHAISE

Scale: 1/4" = 1'-0"

Scale: 1/4" = 1'-0"

This schematic is current as of Sept 2024.
Lazar reserves the right to change dimensions
and/or products offered. A more recent schematic may
be available for this series at www.lazarind.com

*NOTE: L or R is determined by facing the piece.