

164820
TWO ARM SOFA

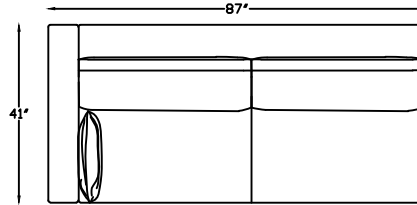

164817L
ONE-ARM SOFA
(SHOWN AS LEFT)

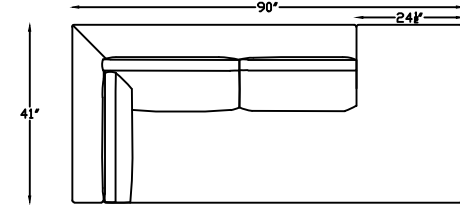

164818R OR L
RETURN SOFA W/ BUMPER
(SHOWN AS RIGHT)

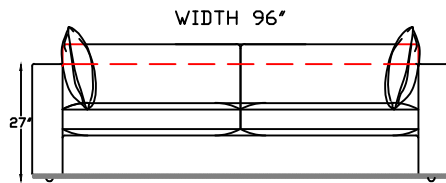

*FRONT VIEW

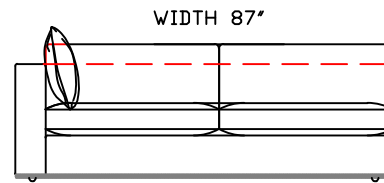

*FRONT VIEW

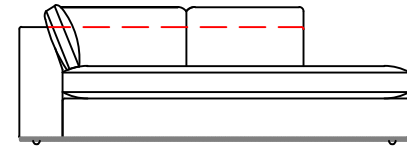

*FRONT VIEW

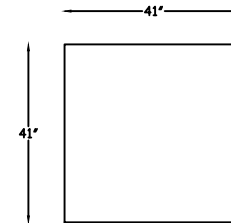

164801
OTTOMAN

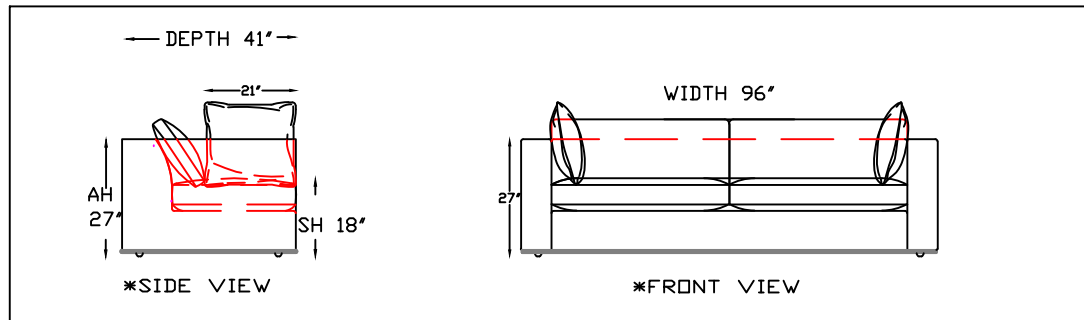

This schematic is current as of October 07, 2021
 Lazar reserves the right to change dimensions and/or products offered.
 A more recent schematic may be available for this series at www.lazarind.com
 NOTE: L or R is determined by facing the piece.